

# INSTALLATION & USER INSTRUCTIONS

## WALL MOUNTED HIGH EFFICIENCY GAS FIRE

# ekofires

Christchurch, Dorset BH23 2BT

Tel: 01202 588 638

Fax: 01202 499 639

www.ekofires.co.uk

e-mail: sales@ekofires.co.uk

### MODELS COVERED BY THESE INSTRUCTIONS

5010, 5020, 5030, 5050 & 5060 GAS FIRES



MODEL SHOWN: EKO 5010

# 3 year guarantee



**IN THE UK ALWAYS USE A GAS SAFE REGISTERED ENGINEER TO INSTALL, REPAIR OR SERVICE THIS APPLIANCE**

Please note : Except where otherwise stated, all rights, including copyright in the text, images and layout of this booklet is owned by Focal Point Fires plc. You are not permitted to copy or adapt any of the content without the prior written permission of Focal Point Fires plc.

**All instructions must be handed to the user for safekeeping. The products covered by this booklet are protected under patent GB2275331C.**

Revision D - 07/16

Section	Contents	Page No.	Section	Contents	Page No.
1.0	Important Notes	2	8.0	Testing and Commissioning	6
2.0	Appliance Data	3	8.1	Operating the Appliance	6
3.0	Installation Requirements	3	8.2	Operating pressure	7
3.1	Room Sizing	3	8.3	Fitting the Decorative Frame	7
4.0	Site Requirements	3	9.0	Briefing the customer	8
4.1	Ventilation	4	10.0	Servicing	8
5.0	Unpacking the Appliance	4	10.1	Servicing the Burner Unit	8
5.1	Component Checklist	4	10.2	Pilot Assembly	9
6.0	Gas Supply Routes	5	10.3	Catalysts	9
7.0	Fixing the Appliance	5	10.4	Testing for Firebox Leakage	9
7.1	Checking the Burner & Spark Gap	6	11.0	Troubleshooting Guide	10

## 1.0 IMPORTANT NOTES

- This appliance is a high efficiency, flueless catalytic flame effect gas fire. It provides radiant and convected warmth both efficiently and safely utilising the latest type of catalytic converter and burner technology.
- The appliance does not require a flue system of any type as the catalytic converter cleans the flue products to provide a complete combustion system, which is intrinsically safe. It is designed to operate on natural gas or LPG and is factory set for operation on the gas type, and at the pressure stated on the appliance data plate.
- The appliance incorporates a combustion monitoring system (Oxygen Depletion System). It must not be adjusted or put out of operation. If replaced then manufacturer's original parts must be used.
- This appliance must be installed by a GAS SAFE registered person to ensure that the size of the room in which the appliance is to be installed is sufficient and the ventilation provision for that room is sufficient for the appliance. Details of how to determine the suitable room size is given in section 3.1 of these instructions and details of how to determine suitable ventilation are given in section 4.1.
- In the event of gas leakage from the appliance, the gas supply must be turned off at the nearest isolating valve.
- The appliance must be installed in accordance with the following:
  - Manufacturers' Instructions.
  - The Building Regulations issued by the Department for Communities and Local Government, the Building Standards (Scotland) (Consolidation) Regulations issued by the Scottish Development Department.
  - Relevant British standards insofar as the relevant areas are not covered by these instructions.
  - For Republic of Ireland, reference should be made to the current edition of IS813 (the relevant standards governing installation).
- Failure to comply with the above could lead to prosecution and deem the manufacturer's warranty invalid.
- This appliance must be installed in accordance with the rules in force and used only in a sufficiently ventilated space. The appliance is designed to fit various types of situations as described in sections 3.0 and 4.0. The appliance must be installed in a correctly sized room (see section 3.1), and the correct purpose provided ventilation must be provided (see section 4.1).
- On no account should the appliance inlet or outlet openings be blocked or obstructed in any way (see figure 1). **Do not** place objects on top of the appliance. **Do** make sure the appliance is installed on a flat wall.

• It should be noted that heaters create warm air currents. These currents move heat to wall surfaces next to the heater. Installing the heater next to vinyl or cloth wall coverings or operating the heater where impurities in the air (such as tobacco smoke, candle smoke etc.) exist, may cause the walls to become discoloured.

• This appliance is intended as a secondary source of heat only and should not be used in a room without some form of background heating present. If the appliance is used in a room as the sole source of heat, then condensation may occur on colder surfaces within the room.

• On first light up of a new appliance, burning off of high temperature paint and lubricants may occur for the first few hours of operation. During this period some smoke may be emitted from the outlet grille, this should be no cause for concern. Accordingly, the room should be well ventilated with all windows and doors open during this period. During this period the appliance may cause smoke alarms to sound. If this happens, reset the alarms, but do not remove the batteries.

• **WARNING:** Due to the nature of this product the area around the top of the appliance (i.e. the grille) gets very hot. Care should be taken when operating the appliance. The manufacturer of this appliance considers all surfaces as working surfaces with the exception of the control knob. The guard (glass front) is to prevent risk of fire or injury from burns and no part of it should be permanently removed. **It Does Not Give Full Protection For Young Children Or The Infirm.** Where young children, pets, the elderly or infirm are concerned, a suitable fireguard should be used.

• Consult ALL instructions before installation and use of this appliance. This appliance is free from any asbestos material.

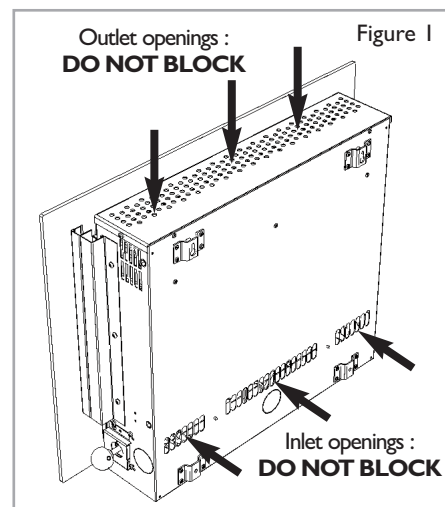

## 2.0 APPLIANCE DATA

GB IE

Model	Country of Destination	Cat	Gas Type	Operating Pressure (±2.0 mbar)				Max Energy Input (kW)		Min Energy Input (kW)	
				G20	G25	G30	G31	Gross	Net	Gross	Net
P23 Natural Gas Models	GB - IE	I <sub>2</sub> H	Natural	20	-	-	-	2.0	1.8	1.0	0.9
P23 LPG models	GB - IE	I <sub>3</sub> P	Propane	-	-	-	37	1.7	1.55	1.0	0.92
L23 Natural Gas Models	GB - IE	I <sub>2</sub> H	Natural	20	-	-	-	2.0	1.8	1.3	1.15
L23 LPG models	GB - IE	I <sub>3</sub> P	Propane	-	-	-	37	1.7	1.55	1.3	1.2

Specifications	NG Models	LPG Models
Main burner Flow Restrictor	Stereo 1.00	Stereo 0.65
Oxypilot	SIT 9082/ Copreci 21100 2F/ 296	SIT 9286/Seagas P5-19
Gas Control	Copreci 21400	Copreci 21400
Gas Inlet	8mm restrictor elbow	8mm restrictor elbow
Ignition	Double Piezo Spark	Double Piezo Spark
Spark Gap	3.5 - 4.5mm	3.5 - 4.5mm

Please see Data Badge affixed to appliance for current data.

This appliance is for use only with the gas type, and at the pressure stated on the appliance Data Badge.

## 3.0 INSTALLATION REQUIREMENTS

If the appliance is to be sited near a disused or unserviceable fireplace served by a natural draught flue then the old flue must be sealed off. It will be necessary to ventilate the old flue to prevent condensation and dampness forming, however any air vent used to ventilate the old flue must not be sited within 500mm of this appliance. If the flue can be ventilated to the outside of the building then this is usually the best solution. If in doubt then advice should be sought from a local building control officer. The appliance is designed to be wall mounted. If the appliance is to be mounted on a newly fabricated area of wall that also serves the purpose of sealing off the old flue then it is very important that there are no holes, gaps or otherwise in this wall that will allow draughts from the old flue to enter the room, especially directly behind the appliance. Such draughts could affect the performance of the ODS system and result in nuisance cutting out, for example. If the gas supply pipe is to enter the appliance from the rear, i.e. emerge from the wall behind the appliance, then any hole in the wall from which the pipe emerges must be tightly sealed. Propane/LPG models must not be installed in cellars, basements or any room which is completely below ground level.

### 3.1 ROOM SIZING

**All Models :** The room size **MUST** be a minimum of 23m<sup>3</sup> (e.g. 10'1" x 10'1" x 8') to allow adequate circulation of air and ensure the correct operation of the fire. This volume may include adjacent spaces but these spaces must not be separated by a door. To calculate a room size in cubic metres (m<sup>3</sup>) divide the room volume in cubic feet (ft<sup>3</sup>) by 35.3.

## 4.0 SITE REQUIREMENTS

### WARNING

This appliance is designed to be wall-hung. Do not recess any part of the appliance into the wall.

This appliance may be installed in any room in the home except bathrooms. In accordance with BS5871 part 4, installation in bedrooms is permitted. If the appliance is to be installed in a bedroom then an electronic carbon monoxide detector complying with the current edition of BSEN 50291 must be installed in the same room as the appliance. For maximum safety it is recommended that such device is continuously (mains) powered and arranged in such a way that the gas supply to the appliance is isolated in the event of an alarm. The selection and installation of such device shall be in accordance with the current edition of BSEN 50292, and the user must be briefed regarding the use and maintenance of such a device.

The appliance is designed to be versatile, and as such will operate correctly when exposed to normal gentle draughts experienced within the home. It is not recommended, however that the appliance be installed in areas where it is likely to be directly exposed to persistent strong draughts, that may be generated by outside doors, windows, air vents, air conditioning units, extractor fans, ceiling fans etc. See section 4.1 for more information on ventilation.

#### **Clearances to non-combustible materials**

Non combustible surfaces are defined as brick, metal, marble, concrete etc. and also a number of man-made materials impervious to flame. If in doubt refer to the material manufacturer for further information before proceeding with installation.

Clearances to the sides of the appliance are 100mm (4"). Clearance to the front of the appliance is 500mm (20").

The back of the appliance may be installed directly onto a non-combustible wall, providing the area behind the appliance is flat and does not interfere with the various vent holes in the back panel of the appliance. A non combustible shelf of any depth may be positioned above the appliance provided it is no closer than 400mm (16") from the top of the appliance glass panel and the wall above the appliance is non combustible. The appliance must not be positioned vertically within 60mm (2.4") of a solid floor (i.e. wood or stone) or hearth. This dimension is measured vertically to the bottom of the appliance firebox.

#### **Clearances to combustible materials**

Combustible materials are defined as wood, fabrics, or other materials likely to combust if exposed to flame. Generally, any material, which is likely to discolour, melt or misshape when exposed to moderate heat, should be considered as a combustible material or surface. Clearance to the sides of the appliance are 100mm (4") but curtains, drapes and other fabrics are not permitted within a distance of 500mm (20") of the appliance sides. No such materials are permitted directly above the appliance regardless of distance.

The minimum clearance to the ceiling above the appliance is 800mm (31.5”) measured from the top of the appliance glass panel. Combustible materials should not be positioned directly in front of the appliance within a distance of one metre. Under no circumstances should any electrical equipment e.g. plasma/LCD screen TV sets etc. be positioned on the wall above the appliance. The appliance is designed to be wall mounted alone and not in conjunction with any type of combustible fire surround. No combustible shelves should be positioned on the wall above the appliance. It should be established that any mirrors or picture frames etc. to be positioned on the wall above the appliance are able to withstand prolonged exposure to moderate heat and moisture before proceeding with their installation.

The back of the appliance may be installed directly onto a combustible wall, providing it is relatively flat and does not interfere with the various vent holes in the back panel of the appliance. The wall must be structurally sound and constructed from a material capable of withstanding moderate heat. Brick, concrete, finished plaster, most types of conventional wall paper and dry-lined plasterboard are usually examples of suitable materials, however as there are many methods of wall construction and many variations in the composition of construction materials, in some circumstances, cracking may occur to plasterwork. Materials such as flock, blown vinyl and embossed paper which are sensitive to even small amounts of heat should be avoided as scorching and or discolouration may occur over time. Avoid siting the appliance near joins or joints in plasterboard as exposure to moderate heat may cause cracking along the joint line.

If the appliance is to be mounted on a dry lined wall or a timber framed construction wall then the integrity and ability of the wall to carry the weight of the appliance must be confirmed. It is important in these circumstances that any vapour control barrier is not damaged, and that any structural members of the house frame are not damaged - refer to section 7.0. The appliance must not be positioned vertically within 100 mm (4”) of a carpeted floor, rugs or fabric materials of any kind. This dimension is measured vertically to the bottom of the appliance firebox.

## 4.1 VENTILATION

A minimum of 100 cm<sup>2</sup> purpose provided ventilation **MUST** be provided for this appliance. This may be achieved either with one vent 100 cm<sup>2</sup> at a high or low position in the room, or split ventilation i.e. 50cm<sup>2</sup> be installed at high level and 50cm<sup>2</sup> be installed at low level within the room. An openable window or equivalent is also required.

To reduce the possibility of draughts, road noise or insects entering the room via the air vent, we recommend the use an air vent of the type that feature internal baffles. The requirements of any other gas, oil or solid fuel appliances operating in the same room or space must be taken into consideration when assessing ventilation. Any ventilation fitted must comply with BS 5871 part 4 and BS 5440 part 2.

Ventilation fitted under, or within immediate vicinity of the appliance must not be used as it may adversely effect performance of the ODS system. The appliance shall not be installed within one metre of any existing air vent, and any new air vent shall not be installed within one metre of the appliance.

For Republic of Ireland refer to the current edition of IS813 and any relevant rules in force.

## 5.0 UNPACKING THE APPLIANCE

Remove the outer packaging, remove any instructions or fixing kits. Read ALL these instructions before continuing to unpack or install this appliance. Lift off the remaining packaging components and remove the contents of the box. Check that the components supplied correlate with the component checklist. Please dispose of all the packaging materials at your local recycling centre.

### 5.1 COMPONENT CHECKLIST

QUANTITY	DESCRIPTION
1	Firebox and burner assembly
1	Set of manufacturers instructions
1	Decorative facia
1	Screw and wall plug pack
1	Rubber grommet
1	Fitting template

## 6.0 GAS SUPPLY ROUTES

There are four possible entry points for the gas supply pipework to enter the appliance firebox. These entry points are 'knock out' type holes. Non-concealed gas connections may be made using the entry points at either end of the firebox or the one in the bottom of the firebox. A concealed gas connection may be made using the knock out hole in the centre back of the firebox. Select the most appropriate entry point and knock out the relevant hole

No more than 1.5m of 8mm diameter pipe must be used to avoid unnecessary pressure drops.

If a concealed gas connection is to be made, the supply pipe should always be sleeved through walls and floors using the shortest possible route. For concealed supply pipe routing, pipes must (where possible) be vertical and providing there is sufficient wall thickness available, they should be placed in pipe chases. Horizontal pipe runs should be avoided. Prior to chasing a solid wall, an inspection should be made to note the proximity of any cables/sockets outlets which may already be buried.

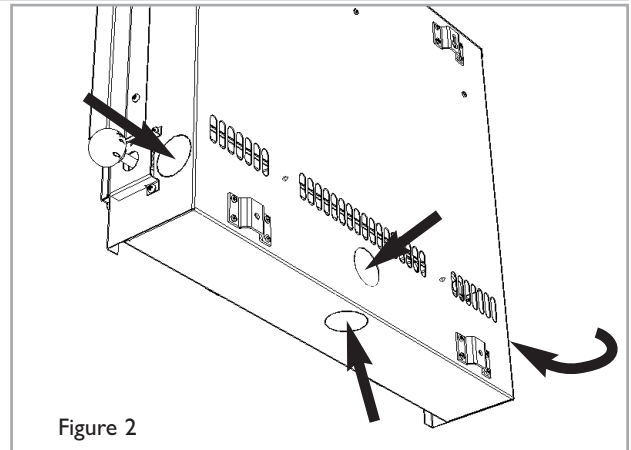

Figure 2

Pipes must be secured using suitable clips and protected against corrosion. Ideally factory finished protected pipework and fittings should be used. Joints should be kept to a minimum and compression fittings must not be used. The pipework installation must be tested for soundness before any protection is applied and/or the pipework and fittings are buried.

## 7.0 FIXING THE APPLIANCE

### ! WARNING

The wall where the appliance is to be installed must be capable of long-term support of the total load of the appliance. Measures should also be taken to ensure sufficient strength to withstand the force of earthquakes, vibration and other external forces.

Remove any protective film coatings from the finished/decorative surfaces of the appliance. After having selected the final mounting position of the appliance, taking into account the requirements as specified in sections 3 and 4 of these instructions, the integrity of the wall, and the feasibility of the proposed supply pipe routing, the firebox of the appliance may be secured to the wall.

To ensure customer safety, be sure to design the installation so that the strength of both the wall and any wall fixings used are sufficient.

Focal Point Fires plc. assumes absolutely no responsibility for injuries and/or damages that may occur due to improper installation or handling. The appliance should not be installed until all wet plastering and/or dry wall sanding and wall painting has been completed. Do not block the ventilation holes of the appliance.

The wall onto which the appliance is installed must be flat. Install only on a vertical surface. Avoid sloped surfaces. Installation onto anything other than a vertical wall may result in fire, damage or injury. If the appliance is to be mounted on the inner leaf of a conventional cavity brick wall, or a solid wall, then the wall plugs and fixing screws provided may be used. Depending on the condition of the wall it may be necessary to use additional fixings. In this situation, any additional fixings and wallplugs should be of the same size and type as the ones provided. At the appropriate stage of the installation, drill four holes using only a 8mm masonry bit to a depth of 42mm. Insert the wallplugs provided ensuring they are flush to the wall.

### ! WARNING

Plasterboard alone is not considered to be a structural material. It is not recommended to rely on plasterboard fixings alone to support the weight of the appliance.

If the appliance is to be mounted on a dry lined wall or a timber framed construction wall then efforts should be made to fix in at least two positions vertically, into one of the wooden studs, or supporting wooden members of the wall using two of the fixing screws provided. If this is not achievable then the wall should be strengthened using appropriate building materials.

If there is no alternative than to rely on some plasterboard fixings then special cavity screw

fixings or hollow wall anchors will be required which are not supplied with this product. These should be constructed from metal and not plastic and of the design indicated in figure 3. For further guidance for wall fixing in timber framed buildings refer to any relevant local codes of practice.

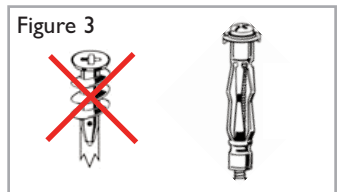

Figure 3

### Flat Wall Fixing - All Models

To assist with fixing the appliance, a template is provided as shown in figure 4.

P23 models : Mark the positions shown as "Fixing points model P23" on the wall.

L23 Models : Mark the positions shown as "Fixing points model L23" on the wall.

If a concealed gas connection is to be made ensure the gas supply pipe is in its final position and can enter the appliance in the correct position when the appliance is hung on the wall. Drill the wall as appropriate for the type of wall as previously described in this section, and insert the chosen type of wall fixings. Insert the wall fixing screws into the top wall plugs, taking care to leave the screws protruding approximately 5mm from the wall.

Now hang the appliance onto these screws through the two keyhole shaped holes in the upper brackets on the back panel of the appliance. Insert the lower fixing screws into the

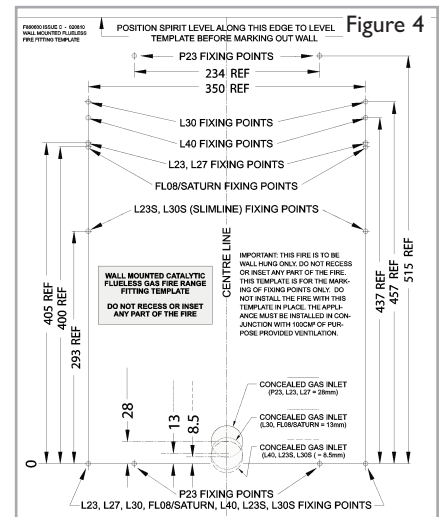

Figure 4



## 7.0 FIXING THE APPLIANCE (CONTINUED)

GB IE

lower wall plugs through the corresponding fixing holes in the lower part of the back panel. Do not tighten fully. Before tightening the wall mounting screws fully, at this stage it is recommended to check the horizontal alignment of the appliance with a spirit level, as small adjustments can still be made if necessary. When this has been checked, tighten all four fixing screws fully. To access the upper fixing screws insert a screwdriver through the round access holes in the front face of the outlet grille (as shown in figure 5).

These access holes are located in the same position on all models.



Figure 5

## 7.1 CHECKING THE BURNER AND SPARK GAP

There are no imitation fuel bed components to install. The appliance features a ribbon burner which is designed to produce a continuous band of flame over its length.

The burner should be visually inspected to ensure it is free from any foreign matter.

If it is necessary to clean or dust off the burner then the glass door should be removed by removal of the four retaining screws. Re-fit the glass door after cleaning or inspection, ensuring correct orientation and a good seal. The gap between the spark electrode and the pilot should be 3.5 - 4.5mm to produce a good spark (see figure 6). There should be no need to adjust this. If under any circumstances the piezo electric spark fails, the pilot cannot be lit manually.

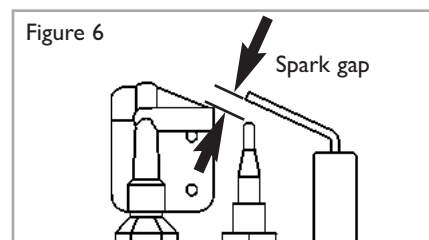

Figure 6

## 8.0 TESTING AND COMMISSIONING

Turn on and test the gas supply up to the fire for any leaks, in accordance with the current edition of BS 6891 (natural gas installations) or the current edition of BS 5482 pt1 (propane installations). For Republic of Ireland, reference should be made to the current edition of IS813 (the relevant standards governing installation).

## 8.1 OPERATING THE APPLIANCE

The control knob is located on the lower right hand side of the outer case. It is marked as shown in figure 8.

• **All models :** The pilot is visible behind the left hand side of the burner. Push the control knob in fully and turn anti-clockwise through both of the SPARK positions, keeping fully depressed, hold there for a few seconds. If the fire has not been used for some time, hold the knob in this position for longer, to allow any air in the pipes to be purged. Continue turning anti-clockwise through the spark clicks to the nine o'clock position, ensuring the pilot has lit. If not, return the knob clockwise, and repeat. When the pilot lights after one of the two sparks, keep the knob depressed in the nine o'clock position for approximately ten seconds. Now release the knob and the pilot should stay alight. If the pilot is extinguished during use, wait three minutes before repeating the ignition procedure. To achieve the HIGH setting, push the control knob in slightly and continue turning anti-clockwise to the high position. The main burner should light after a few seconds. To decrease the setting to LOW, push the knob in slightly and turn the control knob clockwise to the low setting. To turn to the pilot only position from the HIGH or LOW positions, press the control knob in, and return to the nine o'clock position and release. To turn the fire OFF, keep the knob pressed in, return to the off position and release.

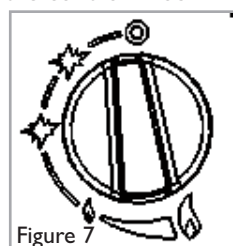

Figure 7

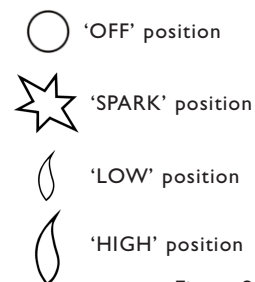

Figure 8

## 8.2 OPERATING PRESSURE

The pressure test point is located on the inlet restrictor elbow in the centre of the burner as shown in figure 9. Release the pressure test point screw, and attach a pressure gauge. Light the fire on the HIGH setting. To commission the appliance, the operating pressure must be in accordance with the figures stated in section 2.0 of these instructions. The fire is factory set to achieve the correct flow rates at the specified inlet pressure.

Any significant variation in the operating pressure could indicate a supply problem. If the inlet pressure is too high, the gas supply meter/governor may be set incorrectly. This should be checked with the fire running and if necessary reset by the gas supplier. If the operating pressure is too low, then check the meter/governor pressure with the appliance running. If this is less than the inlet pressure stated in section 2.0 of these instructions it will need to be reset by the gas supplier. If the inlet pressure is too low, but the meter/governor pressure is acceptable, then a problem in the supply pipework is to be suspected.

Upon satisfactory checking of the inlet pressure, turn the fire off, disconnect the pressure gauge and refit the test point screw. Light the fire and check for gas soundness. In the event that the inlet pressure is not in accordance with the figures stated in the data section of these instructions, the appliance must not be commissioned, and the problem investigated and rectified.

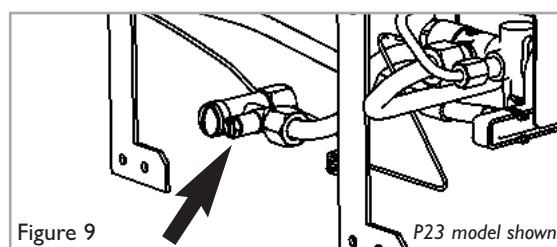
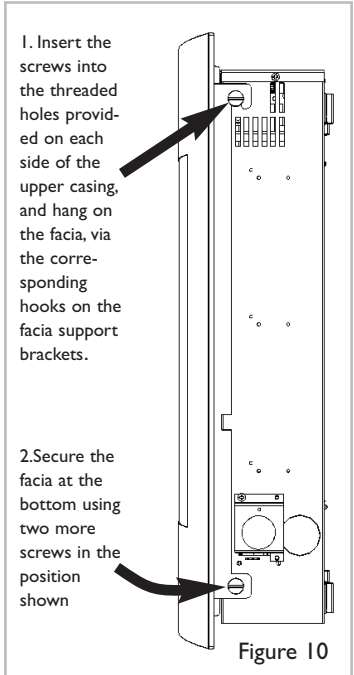

Figure 9

**All models :** Ensure all/any protective film is removed as the facia may be damaged if the fire is lit with the facia in position whilst still covered in film.

**P23 & L23 models:** The facia panel is supplied attached to the fire. To remove the facia panel, first, remove the lower retaining screws (one on each side of the appliance). Simply lift the frame upwards. Refitting is the reverse of removal. Ensure the cut-outs in the bottom of the frame support brackets engage the lower screws on each side of the appliance. See figure 10.



**L23 models :** The glass facia panel is supported by four M6 screws which protrude from the front of the outer casing. Ensure each screw is unscrewed approximately one turn from the fully screwed in position in order to create a 2mm gap (shown in figure 11). Simply hang the facia panel onto the outer casing ensuring that the corresponding keyhole shaped holes engage the screw-heads fully (see figure 12).

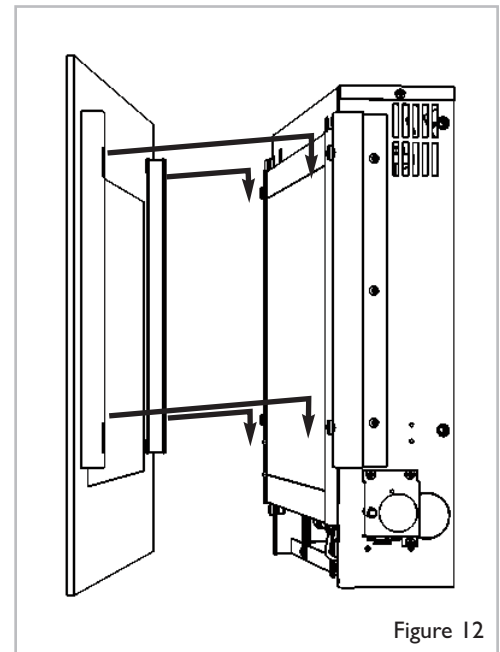
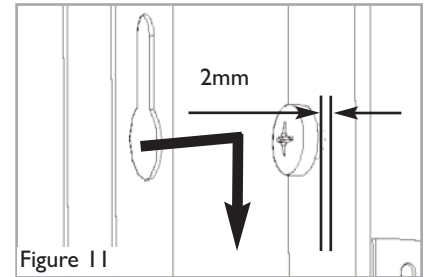

All instructions must be handed to the user for safekeeping. Show the customer how to light and control the fire. After commissioning the appliance, the customer should be instructed on the safe use of the appliance and the need for regular servicing. Frequency of service depends on usage, but **MUST** be carried out at least once annually. Advise that cleaning of the fire may be achieved when the fire is cold using a damp cloth and mild detergent on most surfaces. Advise that on first light up of a new appliance, initial curing of high temperature paint and burning off of lubricants may occur for the first few hours of operation. During this period some smoke may be emitted from the outlet grille, this should be no cause for concern. Accordingly, the room should be well ventilated with all windows and doors open during this period. During this period the appliance may cause smoke alarms to sound. If this happens, reset the alarms, but do not remove the batteries. Recommend that a guard be used for the protection of the young, pets, the elderly and the infirm. Advise the customer that the ventilation openings should not be blocked or obstructed in any way. Isolate the fire from the gas supply. Ensure that the fire is fully cold before attempting service.

## 10.0 SERVICING

A suggested procedure for servicing is detailed below.

1. Lay out the dustsheet and tools.
  2. Remove the decorative frame/glass facia assembly (See section 8.3).
  3. Remove the glass door assembly and clean carefully.
  4. Inspect the burner and the catalyst and clean if necessary with a soft brush.
  5. Detach the burner front cover plate by removal of the four retaining screws. Undo the two screws retaining the burner support bracket to the base and rear of the firebox. Remove the control knob and spindle assembly from the valve by removal of the spindle retaining clip.
  6. Disconnect the gas supply.
  7. Remove the burner unit, strip off the burner pipes and clean thoroughly.
  8. Clean the in-line restrictor, pilot assembly and the burner tube. Do not attempt to remove the pilot injector as this can cause damage.
  9. Re-assemble components.
  10. Turn on the gas supply and leak test. Check pilot and burner for good ignition.
  11. Refit the glass door assembly, ensuring correct orientation and a good seal.
  12. Refit the decorative facia/frame assembly as detailed in section 8.3.
  13. Check the purpose provided ventilation is un-obstructed.
  14. Light the fire and test operating pressures.
  15. Check safe operation of the appliance by performing a combustion test as detailed in section 10.3.
- For specific servicing instructions, see relevant sections.*

### 10.1 SERVICING THE BURNER UNIT AND GAS ASSEMBLY

Firstly, remove the decorative facia assembly - this is the reverse of that described in section 8.3. Remove the inner glass panel, and disconnect the gas connection inside appliance. The gas connections to the gas valve can now be released. Detach the burner front cover plate by removal of the four retaining screws. Undo the four screws retaining the burner support brackets to the base and rear of the firebox, and remove the control knob and spindle assembly by removal of the spindle retaining clip. The burner may now be removed. Remove the pilot and main burner pipes and blow through to dislodge any debris. Now remove the restrictor elbow and blow through to make sure it is entirely clear.

Unclip the pilot lint gauze and clean with a soft brush. Clean the exterior of the pilot assembly with a soft brush and blow through the flame ports on the pilot head. Check the aeration holes are free from lint or dirt. The pilot assembly can be removed if required by disconnecting the electrode HT lead, gas pipe and unscrewing the mounting screws and lifting away.

The pilot assembly is a non-serviceable item and should not be taken apart. Aeration holes must be absolutely clear internally for proper operation.

#### **NEVER MODIFY OR BEND THE THERMOCOUPLE TO MAKE THE PILOT STAY ALIGHT.**

Modifications are dangerous and can have serious unseen effects on safety. If the pilot will not stay lit there is a problem with dirt, the gas supply to it, or the thermocouple needs replacement.

The gas valve is a non-serviceable item. If this needs replacement, remove M20 securing nut holding the valve in place, remove all pipe unions, electrode lead, thermocouple lead and then the complete valve. Replacement must be original manufacturers parts. Re-assembly is the reverse of removal. Ensure operating pressures are as stated in Section 2; Appliance Data.



## 10.2 PILOT ASSEMBLY

GB IE

Remove the burner unit as detailed in section 10.1, then remove the lint arrestor and pilot unit by using a screwdriver to remove the retaining screws. Clean the pilot assembly with a soft brush and blow through. Check the aeration holes are free of any dirt or lint. Clean thoroughly internally, the connection can be removed from the base of the pilot unit using two spanners to make cleaning easier. Do not damage or try to dismantle the pilot injector.

The unit is factory set and the only check necessary is to ensure the spark gap is correct. See specifications for gap setting.

### **NEVER MODIFY OR BEND THE THERMOCOUPLE TO MAKE THE PILOT STAY ALIGHT.**

If the pilot will not stay lit there is a problem with dirt, the gas supply, or the thermocouple needs replacement. Modifications are dangerous and can have a serious unseen effect on safety and therefore **MUST** not be done. Replacements must be original manufacturers parts. Re-assembly is the reverse of removal. Ensure operating pressures are as stated in Section 2; Appliance Data.

## 10.3 CATALYSTS

It is recommended that the catalysts are inspected for signs of damage and dirt during routine servicing procedures. The expected life of the catalysts is in excess of 11,000 hours (10 years of normal use). After this time the catalysts should be replaced.

If there are any deposits of dirt or soot on the catalyst they should be cleaned with a soft brush and a vacuum cleaner. If removed for cleaning ensure the seals are in good condition before replacing the catalyst. New seals will usually be required. The performance of the catalysts may be checked using a combustion gas analyser as follows. Any analyser used should conform to EN 50379-3. Ignite the fire as per the operating instructions, and run at maximum setting for 15 minutes. Position gas sample probe directly over the catalysts via the outlet grille, on top of the appliance. Record the carbon dioxide (CO<sub>2</sub>) concentration and then the carbon monoxide (CO) concentration as displayed by the analyser - also noting the units in which the values are expressed. Most analysers display carbon dioxide (CO<sub>2</sub>) concentrations in percentage (%) terms and carbon monoxide concentration in parts per million (ppm) terms.

In order to calculate the combustion ratio for the appliance (CO/CO<sub>2</sub>) it is first necessary to express both gas concentrations in terms of percentage. To convert from parts per million (ppm) to a percentage (%) divide the ppm figure by 10,000. Examples : 35ppm = 0.0035%, 15ppm = 0.0015%, 5ppm = 0.0005%. Now divide the concentration of carbon monoxide (CO) expressed in percent by the concentration of carbon dioxide (CO<sub>2</sub>) to obtain the appliance combustion ratio.

$$\frac{\text{CO (\%)}}{\text{CO}_2 (\%)} = \text{ratio}$$

### **The combustion ratio of the gasses emitted by the catalytic convertor should not exceed 0.0015.**

If replacing, firstly, remove the decorative frame/glass facia (as described in section 8.3) and outer casing. The catalysts are located on the top of the internal firebox and can be removed by unscrewing the retaining nuts securing the clamping plates. Remove the catalysts their seals and discard. Refit the new catalysts and seals in reverse order, ensure the catalysts and the glass door have good seals.

## 10.4 TESTING FOR FIREBOX LEAKAGE

Appliances that are several years old or have been extensively dismantled should be checked for soundness. It is important that all the products of combustion pass through the catalytic converter at the top of the firebox before leaving the appliance. The firebox is heated by lighting for a few minutes to provide a flow through the firebox. The burner is then shut off and a smoke pellet or match introduced at the base of the fire underneath the burner tray. Large quantities of smoke will emerge from the top of the appliance, but none should emerge from the joints or gasket faces, especially around the door. It is important to note that the appliance can never be expected to be 100% smoke tight and small quantities of smoke may be seen in corners of joints and gasket faces etc without affecting safety when the fire is in operation.

## 11.0 TROUBLESHOOTING GUIDE

### ***Fire sparks but pilot does not light***

- No gas to fire, check isolators are open and gas supply is on.
- Pipework blockage, clean out.
- Air not fully purged, re purge supply or wait longer.
- Spark earthing to metalwork, reset gap correctly.
- Blocked pilot, clean out internally.

### ***Pilot lights but then goes out***

- Severe restriction in gas supply: clear obstruction.
  - Faulty thermocouple, replace pilot unit.
  - Blocked pilot, clean out.
  - Blocked lint gauze, clean.
  - Hold control knob in for longer.
  - Check control knob does not foul indicator plate.
  - If the pilot will not stay lit there could be a problem with contamination of the gas supply, drafts, room size and/or ventilation or the thermocouple needs replacement. Modifications are dangerous and can have a serious unseen effect on safety.
- NEVER MODIFY OR BEND THE THERMOCOUPLE TO MAKE THE PILOT STAY ALIGHT.**

### ***Fire does not spark at pilot***

- HT lead detached, refit.
- Check the spark gap (see section 7.1).
- Faulty piezo unit, replace.
- Debris shorting out electrode, clean.
- Spark shorting to metalwork under tray, check routing of HT lead under burner.

### ***Fire runs for a time and then cuts off***

- Loose or faulty thermocouple, rectify.
- Blocked pilot, clean out.
- Fire is sited in a draft.
- Door or window has been opened creating a draft.
- Wall on which fire is sited has a hole/holes through which there is a draft.
- Fire is too close to an air vent.
- Fire is sited on disused chimney breast which has not been adequately sealed up.
- Dirt or lint in pilot aeration hole or on the lint gauze, clean thoroughly.
- If the pilot will not stay lit there could be a problem with contamination of the gas supply, drafts, room size and/or ventilation or the thermocouple needs replacement. Modifications are dangerous and can have a serious unseen effect on safety.

**NEVER MODIFY OR BEND THE THERMOCOUPLE TO MAKE THE PILOT STAY ALIGHT.**

### ***Pilot flame shrinks when fire is on high***

- Poor gas flow to fire, check pressure with fire on high.
- If pressure is low, remove any restriction in pipework or valve.
- Check all isolators are adequately sized and fully open.
- Check meter pressure is adequate.
- If the pilot will not stay lit there could be a problem with contamination of the gas supply, drafts, room size and/or ventilation or the thermocouple needs replacement. Modifications are dangerous and can have a serious unseen effect on safety.

**NEVER MODIFY OR BEND THE THERMOCOUPLE TO MAKE THE PILOT STAY ALIGHT.**

### ***Fire smells when first lit or in use***

- Newness smell from brand new appliance.
- Leakage occurring. Carry out leakage test and rectify any problems.
- Combustible materials used in incorrect positions.
- Airborne substances such as cleaning materials/air fresheners are being drawn through the fire.
- Other airborne contaminants such as dust, tobacco smoke, paint vapours.

Section	Content	Page No
1.0	Important Notes	1
2.0	Clearances to Combustibles	1
3.0	Fireguards	2
4.0	Ventilation & Room Size	2
5.0	Operating Instructions	2
6.0	Combustion Monitoring System	3
7.0	Cleaning	3
8.0	Servicing	3
9.0	List of Replacement Parts	3
10.0	Installation Details	3
11.0	Service History	4
12.0	Guarantee - Terms and Conditions	4

## 1.0 IMPORTANT NOTES

• The installation and Servicing of this fire **MUST** only be carried out by a competent person in accordance with local Codes and/or Regulations, Building Regulations and the manufacturer's instructions. Failure to comply with the above could lead to prosecution and invalidate the appliance warranty. In the event of gas leakage from the appliance, the gas supply must be turned off at the nearest isolating valve. This appliance is only suitable for the gas type for which it is supplied.

• Keep a note of the installer's name and address, the original purchase receipt and the date of installation. Failure to produce this information may invalidate the warranty. The appliance should be serviced regularly to ensure continued safe operation. See the servicing section for further reference.

• The guard (glass front) is to prevent risk of fire or injury from burns and no part of it should be permanently removed. **It Does Not Give Full Protection For Young Children Or The Infirm.** Parts of this appliance become naturally hot during use. It is recommended that a suitable fireguard is used, especially where young children, pets, the elderly or infirm are concerned. The manufacturer of this appliance considers all surfaces as working surfaces with the exception of the control knob and control panel.

• Combustible items, such as flooring and furniture and soft wall coverings (such as blown vinyl or embossed paper), low temperature surrounds etc may discolour if fitted too close to the fire. See relevant section for further details on clearances to combustibles. No combustible materials or flooring should protrude onto the hearth (if fitted).

• This appliance incorporates a combustion monitoring system (ODS).

• **DO NOT** burn any foreign material on this fire. Under no circumstances shall the appliance be used if the glass front door or panel has been removed, damaged or is open. On no account should the appliance inlet or outlet openings be blocked or obstructed in any way (see figure 1). **DO NOT** place objects on top of the appliance.

• **WARNING:** Due to the nature of this product the area around the top of the appliance (i.e. the grille) gets very hot. Care should be taken when operating the appliance.

The integral catalysts should be checked by the installer upon servicing to ensure there are no defects or obstructions that may prevent the satisfactory flow of combustion products. The expected life of the catalyst is in excess of 11,000 hours (10 years of normal use). After this time the catalyst should be replaced.

• Should any home improvements be carried out to the property after the fire is installed, such as installation of extractor fans for example, the fire should be re-checked by a competent person for safe operation.

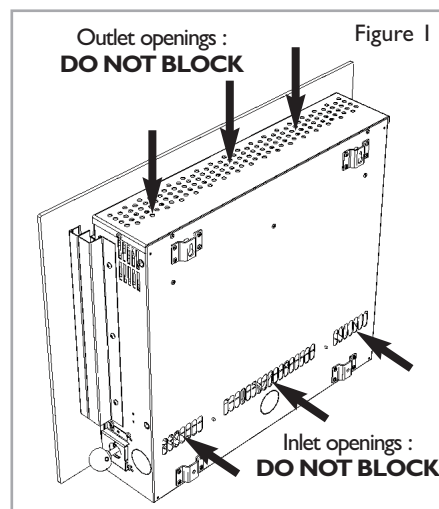

## 2.0 CLEARANCES TO COMBUSTIBLES

### Clearances to non-combustibles

Non combustible surfaces are defined as brick, metal, marble, concrete etc. and also a number of man-made materials impervious to flame. If in doubt refer to the material manufacturer for further information before proceeding with installation.

Clearances to the sides of the appliance are 100mm (4"). Clearance to the front of the appliance is 500mm (20").

The back of the appliance may be installed directly onto a non-combustible wall, providing the area behind the appliance is flat and does not interfere with the various vent holes in the back panel of the appliance.

A non combustible shelf of any depth may be positioned above the appliance provided it is no closer than 400mm (16") from the top of the appliance glass panel and the wall above the appliance is non combustible.

The appliance must not be positioned vertically within 60mm (2.4") of a solid floor (i.e. wood or stone) or hearth. This dimension is measured vertically to the bottom of the appliance firebox.

### Clearances to combustible materials

Combustible materials are defined as wood, fabrics, or other materials likely to combust if exposed to flame. Generally, any material, which is likely to discolour, melt or misshape when exposed to moderate heat, should be considered as a combustible material or surface. Clearance to the sides of the appliance are 100mm (4") but curtains, drapes and other fabrics are not permitted within a distance of 500mm (20") of the appliance sides. No such materials are permitted directly above the appliance regardless of distance. The minimum clearance to the ceiling above the appliance is 800mm (31.5") measured from the top of the appliance glass panel. Combustible materials should not be positioned directly in front of the appliance within a distance of one metre.

**Clearances to combustible materials (continued)**

Under no circumstances should any electrical equipment e.g. plasma/LCD screen TV sets etc. be positioned on the wall above the appliance. The appliance is designed to be wall mounted alone and not in conjunction with any type of combustible fire surround. No combustible shelves should be positioned on the wall above the appliance. It should be established that any mirrors or picture frames etc. to be positioned on the wall above the appliance are able to withstand prolonged exposure to moderate heat and moisture before proceeding with their installation. The back of the appliance may be installed directly onto a combustible wall, providing it is relatively flat and does not interfere with the various vent holes in the back panel of the appliance. The wall must be structurally sound and constructed from a material capable of withstanding moderate heat. Brick, concrete, finished plaster, most types of conventional wall paper and dry-lined plasterboard are examples of suitable materials. Materials such as flock, blown vinyl and embossed paper which are sensitive to even small amounts of heat should be avoided as scorching and or discolouration may occur over time. If the appliance is to be mounted on a dry lined wall or a timber framed construction wall then the integrity and ability of the wall to carry the weight of the appliance must be confirmed. It is important in these circumstances that any vapour control barrier is not damaged, and that any structural members of the house frame are not damaged - refer to section 7.0 of the installation section of these instructions. The appliance must not be positioned vertically within 100 mm (4") of a carpeted floor, rugs or fabric materials of any kind. This dimension is measured vertically to the bottom of the appliance firebox.

**3.0 FIREGUARDS**

The fireguards specified in BS 8423 are intended to protect people from falling into a fire, prevent burns and reduce the risk of injury, particularly to young children and the infirm. In addition it is intended to reduce the risk of fire resulting from clothing and/or other flammable materials coming into contact with, or in proximity to, burning fuel and/or hot surfaces.

Fireguards can be permanently fixed in position or can be moveable, and can incorporate open fires including combination grates, or closed fires, including room heaters and stoves. **See figures 2 & 3 for fireguard examples.**

The fireguards specified are not intended to reduce the risk of fires caused by flying particles, which are covered by BS 3248.

**Figure 2**  
Example of moveable fireguard for portable heating appliances

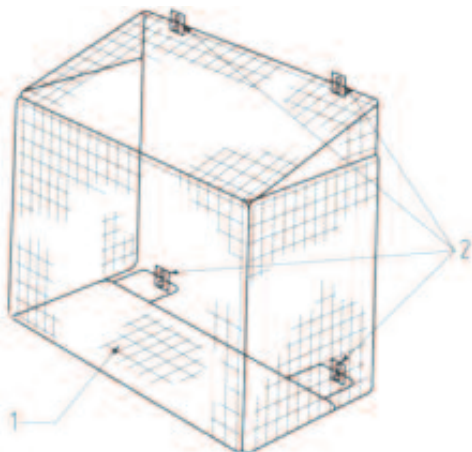
**Key**

1. Optional base section for total enclosure of a wall mounted appliance
2. Points for attachment to a wall.

**Figure 3**  
Example of detachable fireguard

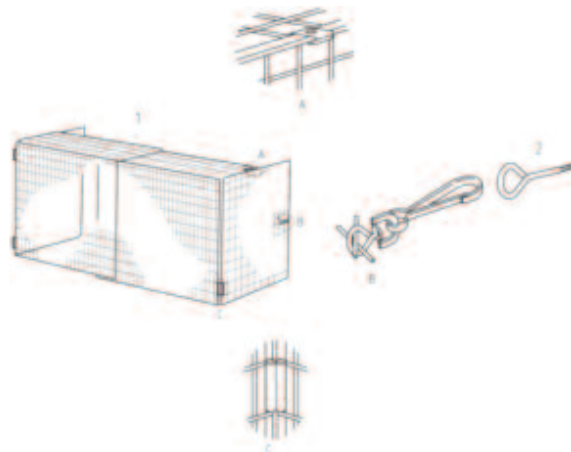
**Key**

1. Detachable fireguard
2. Screw eye

**4.0 VENTILATION & ROOM SIZE**

Purpose provided ventilation of 100cm<sup>2</sup> **MUST** be provided for this appliance.

An openable window or equivalent is also required. Any ventilation fitted must comply with local Codes and/or Regulations. Ventilation fitted under, or within immediate vicinity of the appliance must not be used as it may adversely effect performance of the combustion monitoring system (ODS) system. The appliance shall not be installed within one metre of any existing air vent, and any new air vent shall not be installed within one metre of the appliance.

**WARNING :Ventilation openings must never be blocked or restricted in any way.**

The requirements of other appliances operating in the space or room must be taken into consideration when assessing ventilation requirements, this will have been carried out by your installer. A supply of fresh air into the room is advisable to maintain temperatures within limits. The room size **MUST** be a minimum of 23m<sup>3</sup> (e.g. 10'1" x 10'1" x 8') to allow adequate circulation of air and ensure the correct operation of the fire. This volume may include adjacent spaces but these spaces must not be separated by a door. To calculate a room size in cubic metres (m<sup>3</sup>) divide the room volume in cubic feet (ft<sup>3</sup>) by 35.3.

It should be noted that heaters create warm air currents. These currents move heat to wall surfaces next to the heater. Installing the heater next to vinyl or cloth wall coverings or operating the heater where impurities in the air (such as tobacco smoke, candle smoke etc.) exist, may cause the walls to become discoloured. This appliance is intended as a secondary source of heat only and should not be used in a room without some form of background heating present. If the appliance is used in a room as the sole source of heat, then condensation may occur on colder surfaces within the room. This appliance must not be used in bathrooms. Refer to section 4.0 of the installation manual for guidance on installations in bedrooms.

## 5.0 OPERATING THE APPLIANCE

GB IE

The control knob is located on the lower right hand side of the outer case. It is marked as shown in figure 5.

- **All models :** The pilot is visible behind the left hand side of the burner. Push in and turn the control knob to the SPARK position, and hold there for a few seconds.
- Continue turning anti-clockwise through the double spark click to the PILOT light position, ensuring the pilot has lit. If not, return the knob clockwise, and repeat.
- When the pilot lights after the spark, keep the knob pressed for approximately ten seconds. Now release the knob and the pilot should stay alight.
- If the pilot is extinguished during use, wait three minutes before repeating the ignition procedure.
- To achieve the HIGH setting, push the control knob in slightly and turn fully anti-clockwise to the high position. The main burner should light after a few seconds.
- To decrease the setting to low, turn the control knob clockwise to the LOW setting.
- To turn to the PILOT position from the HIGH or LOW positions, press the control knob in, and return to the pilot position and release.
- To turn the fire off, keep the knob pressed in, return to the OFF position and release.

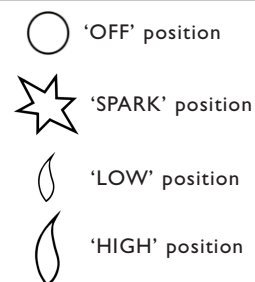
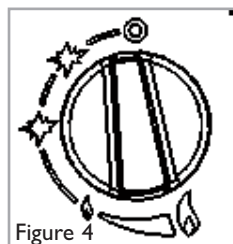

## 6.0 COMBUSTION MONITORING SYSTEM

This fire is fitted with a combustion monitoring safety device (ODS). If the appliance shuts down during use for no apparent reason then several reasons may be suspected. If a door or window has been opened creating a draught, then pilot disturbance could be the problem and removal of the draught should resolve this. The appliance can then be re-lit in accordance with the previous section. If pilot disturbance is not the cause, then the ODS safety system may be in operation. Switch the appliance OFF, call in your installer to check the appliance and ventilation. Remedial work must be carried out as required. **DO NOT** allow the appliance to be used until the appliance and installation is passed as safe. If the pilot continues to be extinguished, you must call your installer to check the operation of the complete appliance.

## 7.0 CLEANING

Before carrying out any of the following operations, ensure that the appliance is OFF and completely cold. Regularly clean around the appliance to ensure that dust, fluff, pet hair etc, are kept to a minimum. There are no other specific requirements for care, other than regular cleaning of the general appliance. A wipe with a dry cloth is normally sufficient. **DO NOT** use abrasive cleaners as they can damage the finish. Metal parts may be cleaned using an appropriate metal cleaner. Test on a hidden part before cleaning. Clean only in the direction of the grain.

GLASS PANEL - This can be cleaned with a suitable glass cleaner. Test on a small area first.

PAINTED AREAS - These can be cleaned using a dry cloth.

## 8.0 SERVICING

The appliance should be checked on an annual basis to ensure it is working safely and that there is no excessive build up of soot. The frequency of service will depend on usage, but **MUST** be carried out at least once annually. Servicing must be carried out by a GAS SAFE registered person. The Installation instructions carry full servicing details for the use of the installer.

## 9.0 LIST OF REPLACEMENT PARTS

PART NO.	ITEM
F960001	Inner glass door assembly (P23 models)
F550339	Inner glass door assembly (L23 models)
F730092	Restrictor - Natural gas
F730095	Restrictor - LPG
F730023	Pilot assembly - Natural Gas (SIT 9082)
F730023	Pilot assembly - Natural Gas (Copreci 21100)
F730075	Pilot assembly - LPG
F730086	Gas valve
TRAY110	Burner unit - Natural gas (P23 models)
TRAY109	Burner unit - Natural gas (L23 models)
TRAY119	Burner unit - LPG (P23 models)
TRAY118	Burner unit - LPG (L23 models)
F780079	Catalyst (seal kit must also be supplied)
F940136	Seal kit for Catalyst

## 10.0 INSTALLATION DETAILS

Name & contact details of installer :		Supplied by :
Installer GAS SAFE registration No :		
Model :		
Fire serial No. :	Date installed :	



# 11.0 SERVICE HISTORY

Date of service	Serviced by (name):	GAS SAFE No. :	Contact details of Engineer

# 12.0 GUARANTEE - TERMS AND CONDITIONS

The 3 year guarantee only covers products purchased on or after 1st February 2009. For all gas fires purchased the 3 year guarantee commences from the date of purchase, provided that the following 3 terms and conditions are adhered to:

**Registration is not required.**

- 1. For any claim to be made within the 3 years from date of purchase you will be required to provide and supply us with your proof of purchase.
- 2. Your gas fire must have been commissioned by a CORGI/Gas Safe\* registered installer, evidence of which you must provide together with the CORGI/Gas Safe\* registration number.
- 3. Your appliance must have been serviced annually, irrespective of use, by a CORGI/Gas Safe\* registered installer, evidence of which must be provided, such as the receipt.

Please note all consumable items such as any ceramics including; coals, pebbles, the matrix, front strips, side cheeks, rear panels and tapered rear panels are not covered by the 3 year guarantee. For all Electric fires purchased the 3 year guarantee commences from the date of purchase, providing that you can supply the proof of purchase. This does not cover consumable items such as pebbles, coals or light bulbs.

**Making a claim is easy.**

If you wish to make a claim under our 3 year guarantee and all the terms and conditions for your product have been met then please submit the following information for the attention of the 3G Service Department to the address below. Alternatively, you can email or fax. Please note that this does not affect your statutory rights.

Focal Point Fires plc, 3G Service Department, Reid Street, Christchurch, Dorset, BH23 2BT.  
 Alternatively email: 3g@focalpointfires.co.uk or fax. 01202 499326.

**Details required:**

- 1. Name, full address including post code and contact telephone number.
- 2. Receipt of purchase or credit card statement.
- 3. Original installers CORGI/Gas Safe\* registration number (gas fires only).
- 4. Annual service receipt for every 12 months (gas fires only).

\*Gas Safe Register replaced CORGI as the gas registration body in Great Britain and the Isle of Man on 1st April 2009.



# ENERG

енергия · ενέργεια



EKO Fires

P23 Flueless Gas Fire

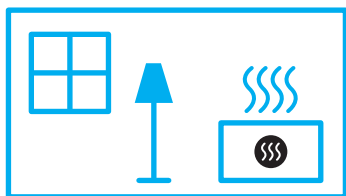
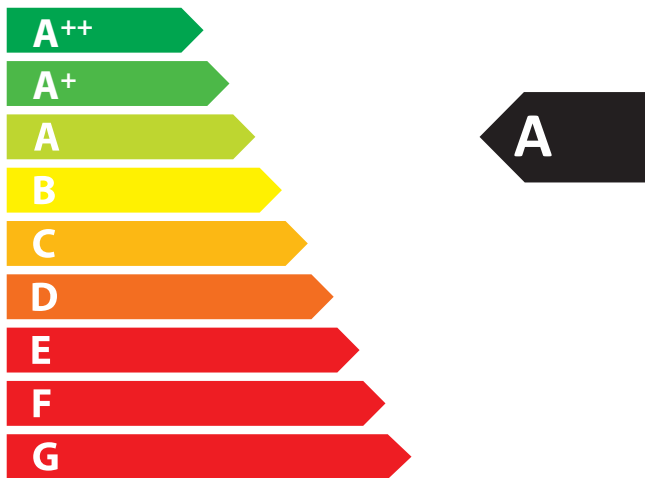

**1,8**  
kW

ENERGIA · ЕНЕРГИЯ · ΕΝΕΡΓΕΙΑ · ENERGIJA · ENERGY · ENERGIE · ENERGI

2015/1186

## Product Fiche

Supplier's name or trademark; EKO Fires

Model identifier; P23 Flueless Gas Fire  
Gas Category/Pressure = I<sub>2H</sub>(20)

Energy Efficiency Class of the model; A

Direct heat output; 1.8 kW

Indirect heat output; N.A.

Energy Efficiency Index; 91

Useful Energy Efficiency at nominal heat output; 100%

Useful Energy Efficiency at minimum load; 100%

Specific precautions that shall be taken when the local space heater is assembled, installed or maintained;

This appliance must be installed, commissioned and maintained by a competent person. Prior to installation the competent person must ensure that the local distribution conditions (identification of the type of gas and pressure) and adjustment of the appliance are compatible.

This appliance must be installed in accordance with the rules in force, and used only in a sufficiently ventilated space of adequate volume. Consult the instructions before installation and use of this appliance.

The competent person must refer to and comply with the specific instructions listed in the Installation Manual before starting to install and commission the appliance.

**Table 1**

**Information requirements for gaseous/liquid fuel local space heaters**

Model identifier(s):		P23 Flueless Gas Fire	
Indirect heating functionality:		[yes/no]	
Direct heat output:		1.8 (kW)	
Indirect heat output:		N.A.	
<b>Fuel</b>			Space heating emissions(*)
			NO <sub>x</sub>
Select fuel type	[gaseous/liquid]	[specify]	[mg/kWh <sub>input</sub> ] (GCV)
	Gaseous	Natural Gas	< 130 t.b.c.
<b>Item</b>	<b>Symbol</b>	<b>Value</b>	<b>Unit</b>
<b>Heat output</b>			
<b>Useful efficiency (NCV)</b>			
Nominal heat output	$P_{nom}$	1.8	kW
Useful efficiency at nominal heat output	$\eta_{th,nom}$	100	%
Minimum heat output (indicative)	$P_{min}$	0.9	kW
Useful efficiency at minimum heat output (indicative)	$\eta_{th,min}$	100	%
<b>Auxiliary electricity consumption</b>			
<b>Type of heat output/room temperature control (select one)</b>			
At nominal heat output	$e_{l,max}$	0.0	kW
			single stage heat output, no room temperature control
At minimum heat output	$e_{l,min}$	0.0	kW
			two or more manual stages, no room temperature control
In standby mode	$e_{l,SB}$	0.0	kW
			with mechanic thermostat room temperature control
			with electronic room temperature control
			with electronic room temperature control plus day timer
			with electronic room temperature control plus week timer
<b>Other control options (multiple selections possible)</b>			
			room temperature control, with presence detection
			room temperature control, with open window detection
			with distance control option
			with adaptive start control
			with working time limitation
			with black bulb sensor
<b>Permanent pilot flame power requirement</b>			
Pilot flame power requirement (if applicable)	$P_{pilot}$	N.A.	kW
Contact details	EKO Fires 10 Avon Trading Park, Christchurch, Dorset, BH23 2BT		

(\*) NO<sub>x</sub>=nitrogen oxides



**ENERG**  
енергия · ενεργεια



EKO Fires

LPG P23 Flueless Gas  
Fire

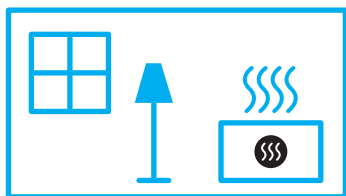
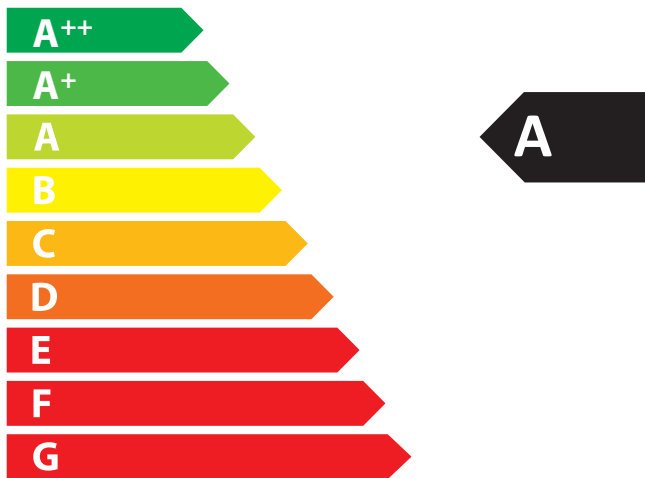

**1,6**  
kW

ENERGIA · ЕНЕРГИЯ · ΕΝΕΡΓΕΙΑ · ENERGIJA · ENERGY · ENERGIE · ENERGI

2015/1186



## Product Fiche

Supplier's name or trademark; EKO Fires

Model identifier; P23 Flueless Gas Fire  
Gas Category/Pressure = I<sub>3P</sub>(37)

Energy Efficiency Class of the model; A

Direct heat output; 1.6 kW

Indirect heat output; N.A.

Energy Efficiency Index; 91

Useful Energy Efficiency at nominal heat output; 100%

Useful Energy Efficiency at minimum load; 100%

Specific precautions that shall be taken when the local space heater is assembled, installed or maintained;

This appliance must be installed, commissioned and maintained by a competent person. Prior to installation the competent person must ensure that the local distribution conditions (identification of the type of gas and pressure) and adjustment of the appliance are compatible.

This appliance must be installed in accordance with the rules in force, and used only in a sufficiently ventilated space of adequate volume. Consult the instructions before installation and use of this appliance.

The competent person must refer to and comply with the specific instructions listed in the Installation Manual before starting to install and commission the appliance.

**Table 1**

**Information requirements for gaseous/liquid fuel local space heaters**

Model identifier(s):		P23 Flueless Gas Fire - LPG					
Indirect heating functionality:		[yes/no]					
Direct heat output:		1.6 (kW)					
Indirect heat output:		N.A.					
<b>Fuel</b>				Space heating emissions(*)			
				NO <sub>x</sub>			
Select fuel type		[gaseous/liquid]	[specify]	<b>[mg/kWh<sub>input</sub>] (GCV)</b>			
		Gaseous	Propane	< 130 t.b.c.			
<b>Heat output</b>							
Item	Symbol	Value	Unit	Item	Symbol	Value	Unit
<b>Heat output</b>				<b>Useful efficiency (NCV)</b>			
Nominal heat output	$P_{nom}$	1.6	kW	Useful efficiency at nominal heat output	$\eta_{th,nom}$	100	%
Minimum heat output (indicative)	$P_{min}$	0.9	kW	Useful efficiency at minimum heat output (indicative)	$\eta_{th,min}$	100	%
<b>Auxiliary electricity consumption</b>				<b>Type of heat output/room temperature control (select one)</b>			
At nominal heat output	$e_{l,max}$	0.0	kW	single stage heat output, no room temperature control	[yes/no]		
At minimum heat output	$e_{l,min}$	0.0	kW	two or more manual stages, no room temperature control	[yes/no]		
In standby mode	$e_{l,SB}$	0.0	kW	with mechanic thermostat room temperature control	[yes/no]		
				with electronic room temperature control	[yes/no]		
				with electronic room temperature control plus day timer	[yes/no]		
				with electronic room temperature control plus week timer	[yes/no]		
				<b>Other control options (multiple selections possible)</b>			
				room temperature control, with presence detection	[yes/no]		
				room temperature control, with open window detection	[yes/no]		
				with distance control option	[yes/no]		
				with adaptive start control	[yes/no]		
				with working time limitation	[yes/no]		
				with black bulb sensor	[yes/no]		
<b>Permanent pilot flame power requirement</b>							
Pilot flame power requirement (if applicable)	$P_{pilot}$	N.A.	kW				
Contact details	EKO Fires 10 Avon Trading Park, Christchurch, Dorset, BH23 2BT						

(\*) NO<sub>x</sub>=nitrogen oxides



# ENERG

енергия · ενεργεια



EKO Fires

L23 Flueless Gas Fire

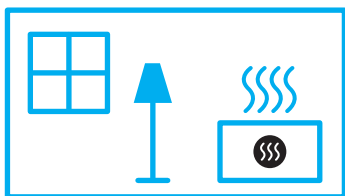
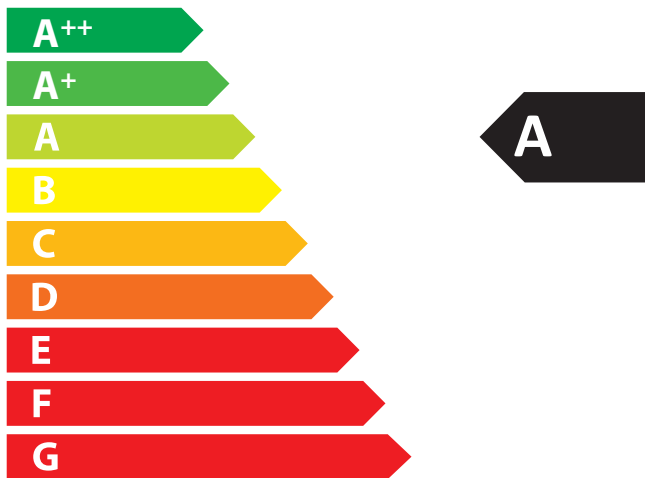

**1,8**  
kW

ENERGIA · ЕНЕРГИЯ · ΕΝΕΡΓΕΙΑ · ENERGIJA · ENERGY · ENERGIE · ENERGI

2015/1186

## Product Fiche

Supplier's name or trademark; EKO Fires

Model identifier; L23 Flueless Gas Fire  
Gas Category/Pressure = I<sub>2H</sub>(20)

Energy Efficiency Class of the model; A

Direct heat output; 1.8 kW

Indirect heat output; N.A.

Energy Efficiency Index; 91

Useful Energy Efficiency at nominal heat output; 100%

Useful Energy Efficiency at minimum load; 100%

Specific precautions that shall be taken when the local space heater is assembled, installed or maintained;

This appliance must be installed, commissioned and maintained by a competent person. Prior to installation the competent person must ensure that the local distribution conditions (identification of the type of gas and pressure) and adjustment of the appliance are compatible.

This appliance must be installed in accordance with the rules in force, and used only in a sufficiently ventilated space of adequate volume. Consult the instructions before installation and use of this appliance.

The competent person must refer to and comply with the specific instructions listed in the Installation Manual before starting to install and commission the appliance.

**Table 1**

**Information requirements for gaseous/liquid fuel local space heaters**

Model identifier(s):		L23 Flueless Gas Fire	
Indirect heating functionality:		[yes/no]	
Direct heat output:		1.8 (kW)	
Indirect heat output:		N.A.	
<b>Fuel</b>			Space heating emissions(*)
			NO <sub>x</sub>
Select fuel type	[gaseous/liquid]	[specify]	<b>[mg/kWh<sub>input</sub>] (GCV)</b>
	Gaseous	Natural Gas	< 130 t.b.c.
<b>Item</b>	<b>Symbol</b>	<b>Value</b>	<b>Unit</b>
<b>Heat output</b>			
<b>Useful efficiency (NCV)</b>			
Nominal heat output	$P_{nom}$	1.8	kW
Useful efficiency at nominal heat output	$\eta_{th,nom}$	100	%
Minimum heat output (indicative)	$P_{min}$	1.2	kW
Useful efficiency at minimum heat output (indicative)	$\eta_{th,min}$	100	%
<b>Auxiliary electricity consumption</b>			
<b>Type of heat output/room temperature control (select one)</b>			
At nominal heat output	$e_{l,max}$	0.0	kW
single stage heat output, no room temperature control			[yes/no]
At minimum heat output	$e_{l,min}$	0.0	kW
two or more manual stages, no room temperature control			[yes/no]
In standby mode	$e_{l,SB}$	0.0	kW
with mechanic thermostat room temperature control			[yes/no]
			with electronic room temperature control [yes/no]
			with electronic room temperature control plus day timer [yes/no]
			with electronic room temperature control plus week timer [yes/no]
<b>Other control options (multiple selections possible)</b>			
			room temperature control, with presence detection [yes/no]
			room temperature control, with open window detection [yes/no]
			with distance control option [yes/no]
			with adaptive start control [yes/no]
			with working time limitation [yes/no]
			with black bulb sensor [yes/no]
<b>Permanent pilot flame power requirement</b>			
Pilot flame power requirement (if applicable)	$P_{pilot}$	N.A.	kW
Contact details	EKO Fires 10 Avon Trading Park, Christchurch, Dorset, BH23 2BT		

(\*) NO<sub>x</sub>=nitrogen oxides





# ENERG

енергия · ενεργεια



EKO Fires

LPG L23 Flueless Gas  
Fire



**1,6**  
kW

ENERGIA · ЕНЕРГИЯ · ΕΝΕΡΓΕΙΑ · ENERGIJA · ENERGY · ENERGIE · ENERGI

2015/1186

## Product Fiche

Supplier's name or trademark; EKO Fires

Model identifier; L23 Flueless Gas Fire  
Gas Category/Pressure = I<sub>3P</sub>(37)

Energy Efficiency Class of the model; A

Direct heat output; 1.6 kW

Indirect heat output; N.A.

Energy Efficiency Index; 91

Useful Energy Efficiency at nominal heat output; 100%

Useful Energy Efficiency at minimum load; 100%

Specific precautions that shall be taken when the local space heater is assembled, installed or maintained;

This appliance must be installed, commissioned and maintained by a competent person. Prior to installation the competent person must ensure that the local distribution conditions (identification of the type of gas and pressure) and adjustment of the appliance are compatible.

This appliance must be installed in accordance with the rules in force, and used only in a sufficiently ventilated space of adequate volume. Consult the instructions before installation and use of this appliance.

The competent person must refer to and comply with the specific instructions listed in the Installation Manual before starting to install and commission the appliance.

**Table 1**

**Information requirements for gaseous/liquid fuel local space heaters**

Model identifier(s):		L23 Flueless Gas Fire - LPG	
Indirect heating functionality:		[yes/no]	
Direct heat output:		1.6 (kW)	
Indirect heat output:		N.A.	
<b>Fuel</b>			Space heating emissions(*)
			NO <sub>x</sub>
Select fuel type	[gaseous/liquid]	[specify]	[mg/kWh <sub>input</sub> ] (GCV)
	Gaseous	Propane	< 130 t.b.c.
<b>Item</b>	<b>Symbol</b>	<b>Value</b>	<b>Unit</b>
<b>Heat output</b>			
<b>Useful efficiency (NCV)</b>			
Nominal heat output	$P_{nom}$	1.6	kW
Useful efficiency at nominal heat output	$\eta_{th,nom}$	100	%
Minimum heat output (indicative)	$P_{min}$	1.2	kW
Useful efficiency at minimum heat output (indicative)	$\eta_{th,min}$	100	%
<b>Auxiliary electricity consumption</b>			
<b>Type of heat output/room temperature control (select one)</b>			
At nominal heat output	$e_{l,max}$	0.0	kW
			single stage heat output, no room temperature control
At minimum heat output	$e_{l,min}$	0.0	kW
			two or more manual stages, no room temperature control
In standby mode	$e_{l,SB}$	0.0	kW
			with mechanic thermostat room temperature control
			with electronic room temperature control
			with electronic room temperature control plus day timer
			with electronic room temperature control plus week timer
<b>Other control options (multiple selections possible)</b>			
			room temperature control, with presence detection
			room temperature control, with open window detection
			with distance control option
			with adaptive start control
			with working time limitation
			with black bulb sensor
<b>Permanent pilot flame power requirement</b>			
Pilot flame power requirement (if applicable)	$P_{pilot}$	N.A.	kW
Contact details	EKO Fires 10 Avon Trading Park, Christchurch, Dorset, BH23 2BT		

(\*) NO<sub>x</sub>=nitrogen oxides